

## IMAGE ORTHICON

The GL-5820 is a television camera tube for outdoor and studio pickup use in which exceptionally high sensitivity is combined with a spectral response approaching that of the eye. It is very stable in performance at all incident light levels on the object ranging from bright sunlight to a deep shadow (several thousand foot-candles to one foot-candle or less). Commercially acceptable pictures can be obtained at incident light

levels greater than about 10 foot-candles.

The GL-5820 has a photocathode characterized by a spectral response with high blue and high green sensitivity, very good yellow sensitivity, and good red sensitivity. It has practically no infrared sensitivity. This particular characteristic of the response permits portrayal of colors in nearly their true tonal gradation since it prevents any color-masking by infrared.

### TECHNICAL INFORMATION

#### GENERAL

##### Electrical

Cathode—Unipotential

Heater Voltage, AC or DC ..... 6.3 ± 10% Volts

Heater Current ..... 0.6 Amperes

Photocathode—Semi-transparent

Response—See spectral sensitivity curve on page 3 for details.

Rectangular Image, 4 by 3 aspect ratio

⊙ Useful Size, maximum diagonal ..... 1.8 Inches

Orientation—Proper orientation is obtained when the vertical scan is essentially parallel to the plane passing through the center of the faceplate and pin No. 7 of the shoulder base.

Focusing Method—Magnetic

Deflecting Method—Magnetic

Direct Interelectrode Capacitance

Anode to All Other Electrodes ..... 12 μf

GENERAL  ELECTRIC

#Supersedes pages 1, 2, 5 and 6 dated 12-56 and 9-57

TECHNICAL INFORMATION (CONT'D)

Mechanical

Over-all Length.....	15.20" ±0.25"	Inches
Greatest Diameter of Bulb.....	3.00" ±0.06"	Inches
Minimum Deflecting Coil Inside Diameter.....	2 <sup>3</sup> / <sub>8</sub>	Inches
Deflecting Coil Length.....	.5	Inches
Focusing Coil Length.....	.10	Inches
Alignment Coil Length.....	1 <sup>5</sup> / <sub>16</sub>	Inches
Photocathode Distance Inside End of Focusing Coil.....	1/2	Inches
Weight, approximate.....	1.4	Pounds
Operating Position—Any, except with diheptal base up and the tube axis at an angle of less than 20 degrees from vertical.		

MAXIMUM RATINGS AND TYPICAL OPERATING CONDITIONS

Maximum Ratings, Absolute Values

Photocathode Voltage.....	— 550 Max	Volts
Photocathode Illumination.....	.50 Max	Foot-Candles
Anode Supply Voltage*.....	1350 Max	Volts
Grid-No. 1 Voltage		
Negative Bias Value.....	125 Max	Volts
Positive Bias Value.....	0	Max Volts
Grid-No. 2 and Dynode-No. 1 Voltage.....	350 Max	Volts
Grid-No. 3 Voltage.....	400 Max	Volts
Grid-No. 4 Voltage.....	300 Max	Volts
Grid-No. 5 Voltage.....	150 Max	Volts
Grid-No. 6 Voltage.....	— 550 Max	Volts
Voltage Per Multiplier Stage.....	350 Max	Volts
Target Voltage		
Positive Value.....	10 Max	Volts
Negative Value.....	10 Max	Volts
Peak Heater-Cathode Voltage		
Heater Negative with Respect to Cathode.....	125 Max	Volts
Heater Positive with Respect to Cathode.....	10 Max	Volts
Operating Temperature of Any Part of Bulb.....	50 Max	C
Operating Temperature of Bulb at Large End of Tube, target section.....	35 Min	C
Temperature Difference		
Between Target Section and Any Part of Bulb Hotter Than Target Section.....	5 Max	C

Typical Operation

Photocathode Voltage, image focus.....	—400 to —540	Volts
Grid-No. 1 Voltage for Picture Cut-off, beam.....	—45 to —115	Volts
Grid-No. 2 and Dynode-No. 1 Voltage.....	.300	Volts
Grid-No. 3 Voltage†, multiplier focus.....	225 to 330	Volts
Grid-No. 4 Voltage, beam focus.....	.140 to 180	Volts
Grid-No. 5 Voltage, decelerator.....	0 to 125	Volts
Grid-No. 6 Voltage, accelerator		
75 Percent of Photocathode Voltage, approximate.....	—300 to —405	Volts
Dynode-No. 2 Voltage.....	.600	Volts
Dynode-No. 3 Voltage.....	.800	Volts
Dynode-No. 4 Voltage.....	1000	Volts
Dynode-No. 5 Voltage.....	1200	Volts
Anode Voltage.....	1250	Volts
DC Anode Current.....	.30	Microamperes
⊕Signal Output Current, peak to peak.....	3 to 24	Microamperes
Target Voltage‡		
□ Target Cutoff Voltage‡.....	—3 to +1	Volts
Target Temperature Range.....	35 to 45	C
Ratio of Peak-to-Peak Highlight Video Signal		
Current to RMS Noise Current, approximate.....	.35	
Minimum Peak-to-Peak Blanking Voltage.....	.5	Volts
Field Strength at Center of Focusing Coil§.....	.75	Gausses
Field Strength of Alignment Coil, approximate.....	0 to 3	Gausses

\* Ratio of dynode voltages is shown under Typical Operation.

† Adjust to give the most uniformly shaded picture near maximum signal.

‡ Adjustable from —3 to +5 volts with blanking voltage off. Normal setting of target voltage is +2 volts from target cutoff.

§ Direction of current should be such that a north-seeking pole is attracted to the image end of the focusing coil, with the indicator located outside of and at the image end of the focusing coil.

⊕Denotes a change.

□Denotes an addition.

SPECTRAL SENSITIVITY CHARACTERISTIC  
FOR EQUAL VALUES OF RADIANT FLUX AT ALL WAVELENGTHS  
DASHED CURVE SHOWS SPECTRAL CHARACTERISTIC OF AVERAGE HUMAN EYE

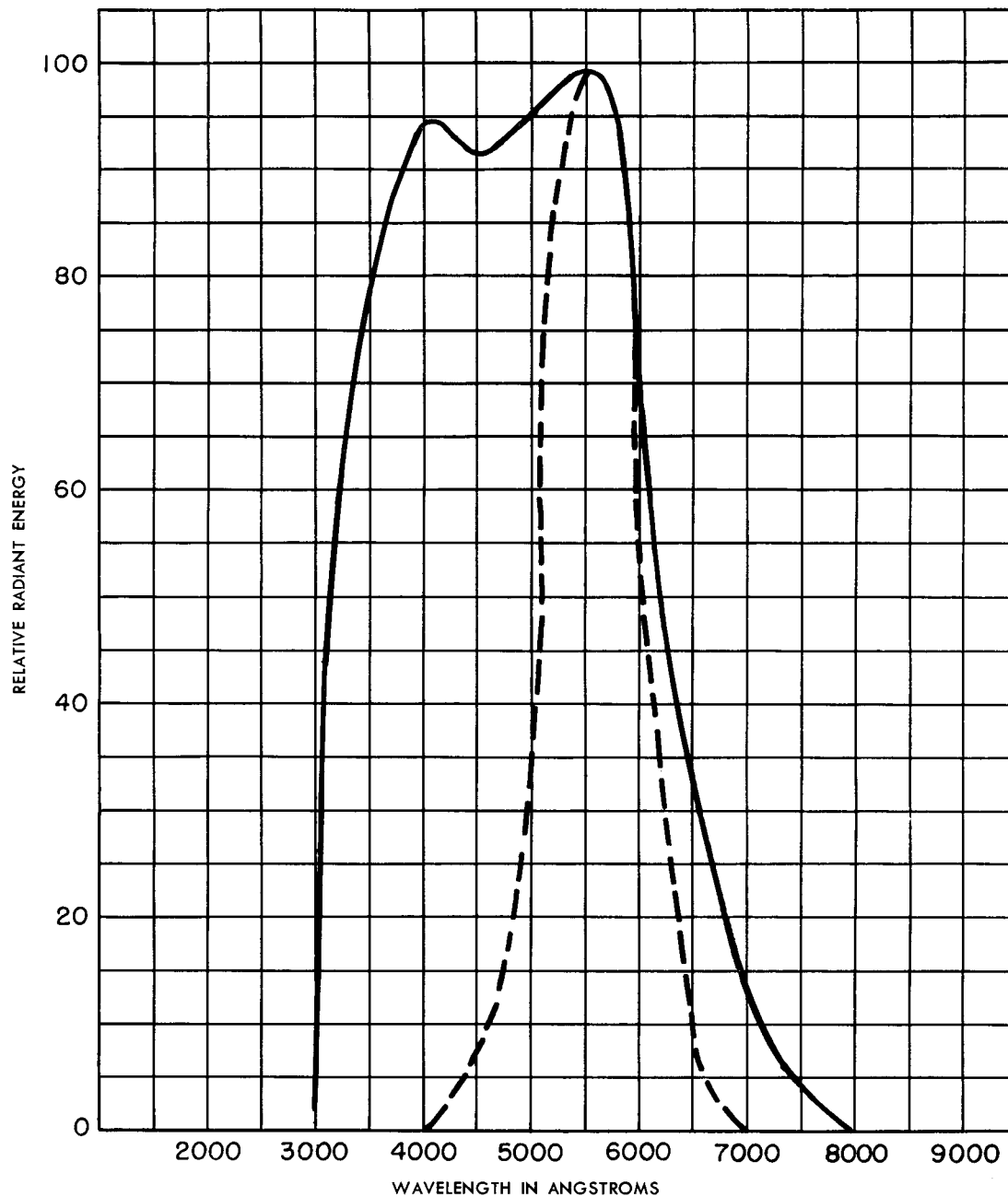

ULTRA VIOLET ← | → INFRARED

↑ VIOLET    ↑ BLUE    ↑ GREEN    ↑ YELLOW    ↑ ORANGE    ↑ RED

TYPICAL SIGNAL OUTPUT  
SCENE: BLACK AND WHITE BALANCED  
TUNGSTEN, DAYLIGHT, OR WHITE FLUORESCENT LIGHT

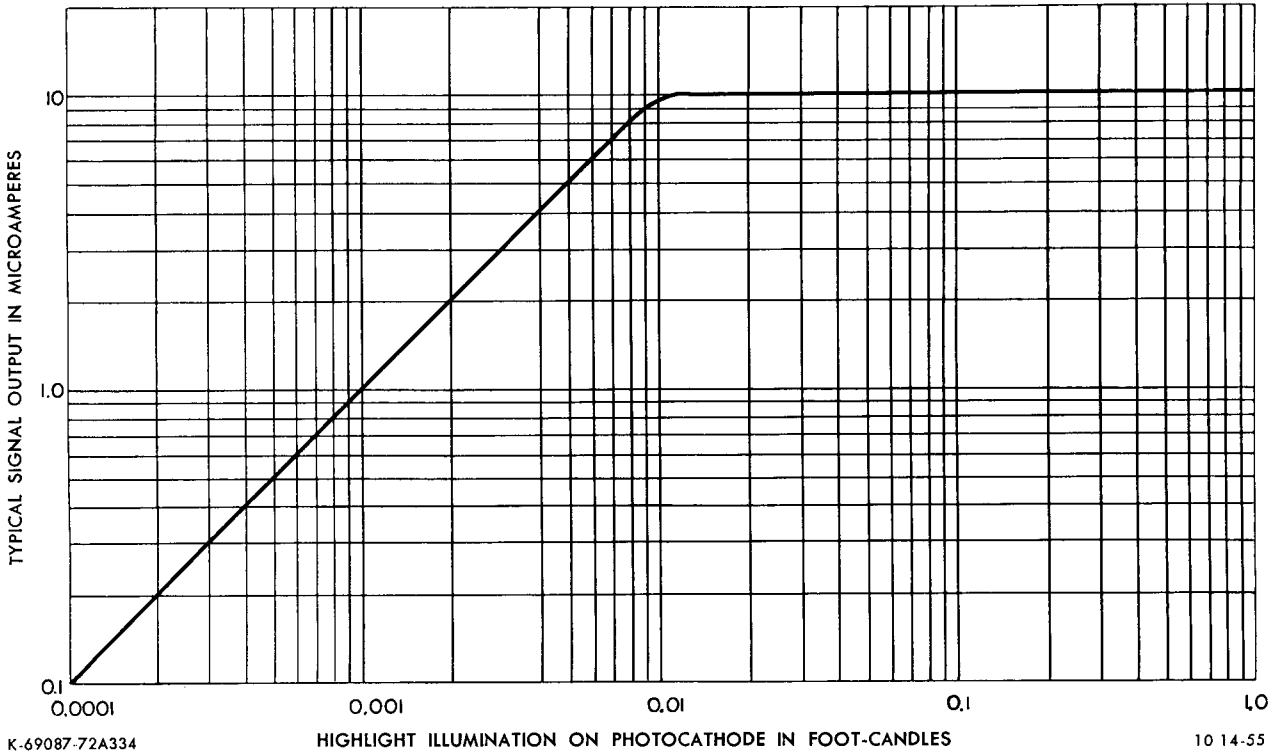

K-69087-72A334

10 14-55

TEMPERATURE EFFECT ON AMPLITUDE RESPONSE

TELEVISION LINE NUMBER = 300

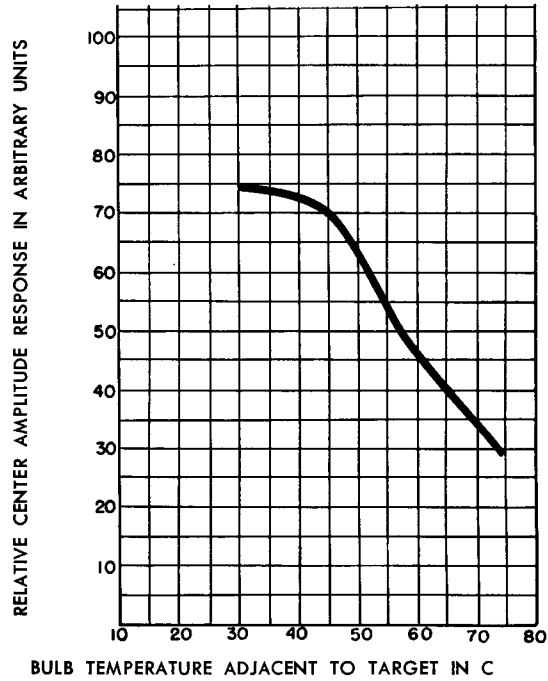

AMPLITUDE RESPONSE CHARACTERISTICS

TEST PATTERN: SQUARE WAVE

OPERATING TEMPERATURE OF BULB ADJACENT TO TARGET = 35 C  
 RESPONSE MEASURED IN SYSTEM HAVING 10 MC BANDWIDTH

CURVE	HIGHLIGHTS IN RELATION TO LIGHT TRANSFER CHARACTERISTIC
A	AT KNEE
B	ONE LENS STOP ABOVE KNEE

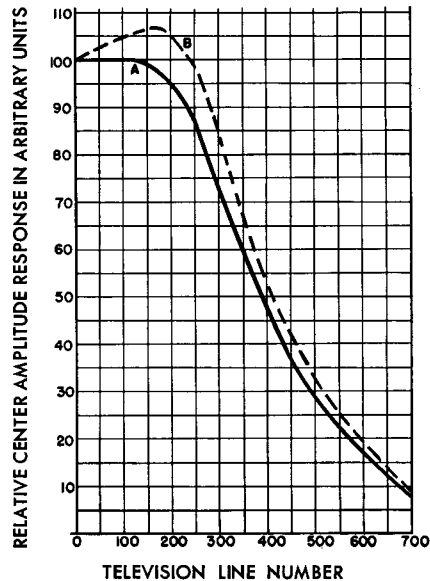

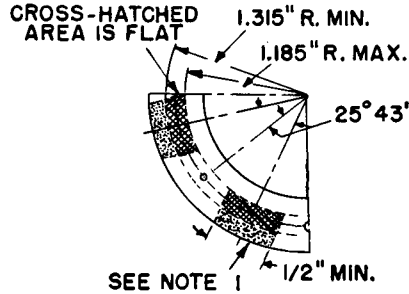
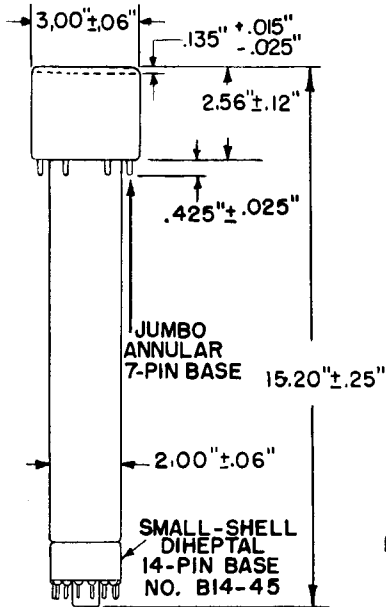

DETAIL OF BOTTOM VIEW OF JUMBO ANNULAR BASE

NOTE 1: DOTTED AREA IS FLAT OR EXTENDS TOWARD DIHEPTAL-BASE END OF TUBE BY 0.060" MAX.

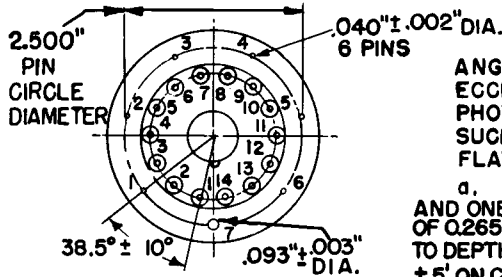

ENLARGED BOTTOM VIEW

- ANNULAR BASE GAGE  
ANGULAR VARIATIONS BETWEEN PINS AS WELL AS ECCENTRICITY OF NECK CYLINDER WITH RESPECT TO PHOTOCATHODE CYLINDER ARE HELD TO TOLERANCES SUCH THAT PINS AND NECK CYLINDER WILL FIT FLAT-PLATE GAGE WITH:
- a. SIX HOLES HAVING DIAMETER OF  $0.065 \pm 0.001$ " AND ONE HOLE HAVING DIA. OF  $0.150 \pm 0.001$ ". ALL HOLES HAVE DEPTH OF  $0.265 \pm 0.001$ ". THE SIX  $0.065$ " HOLES ARE ENLARGED BY  $45^\circ$  TAPER TO DEPTH OF  $0.047$ "; ALL HOLES ARE SPACED AT ANGLES OF  $51^\circ 26' \pm 5'$  ON CIRCLE DIAMETER OF  $2.500 \pm 0.001$ "
  - b. SEVEN STOPS HAVING HEIGHT OF  $0.187 \pm 0.001$ ", CENTERED BETWEEN PIN HOLES, TO BEAR AGAINST FLAT AREAS OF BASE.
  - c. RIM EXTENDING OUT A MINIMUM OF  $0.125$ " FROM  $2.812$ " DIAMETER AND HAVING HEIGHT OF  $0.126 \pm 0.001$ ".
  - d. NECK-CYLINDER CLEARANCE HOLE HAVING DIAMETER OF  $2.200 \pm 0.001$ ".

DIRECTION OF LIGHT: PERPENDICULAR TO LARGE END OF TUBE

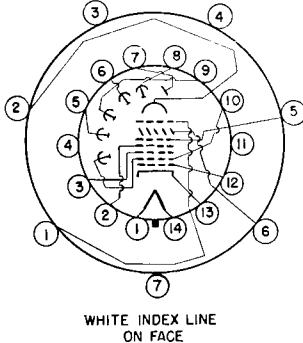

SMALL-SHELL DIHEPTAL 14-PIN BASE

- |  |                                  |   |
|--|----------------------------------|---|
| PIN 1: HEATER                            | PIN 6: DYNODE NO. 4              | PIN 11: INTERNAL CONNEC - TION-DO NOT USE |
| PIN 2: GRID NO. 4                        | PIN 7: ANODE                     | PIN 12: GRID NO. 1                        |
| PIN 3: GRID NO. 3                        | PIN 8: DYNODE NO. 5              | PIN 13: CATHODE                           |
| PIN 4: INTERNAL CONNEC - TION-DO NOT USE | PIN 9: DYNODE NO. 3              | PIN 14: HEATER                            |
| PIN 5: DYNODE NO. 2                      | PIN 10: DYNODE NO. 1, GRID NO. 2 |   |

KEYED JUMBO ANNULAR 7-PIN BASE

- |  |  |
|--|--|
| PIN 1: GRID NO. 6                        | PIN 5: GRID NO. 5                        |
| PIN 2: PHOTOCATHODE                      | PIN 6: TARGET                            |
| PIN 3: INTERNAL CONNEC - TION-DO NOT USE | PIN 7: INTERNAL CONNEC - TION-DO NOT USE |
| PIN 4: INTERNAL CONNEC - TION-DO NOT USE |  |

ELECTRONIC COMPONENTS DIVISION



Schenectady 5, N. Y.

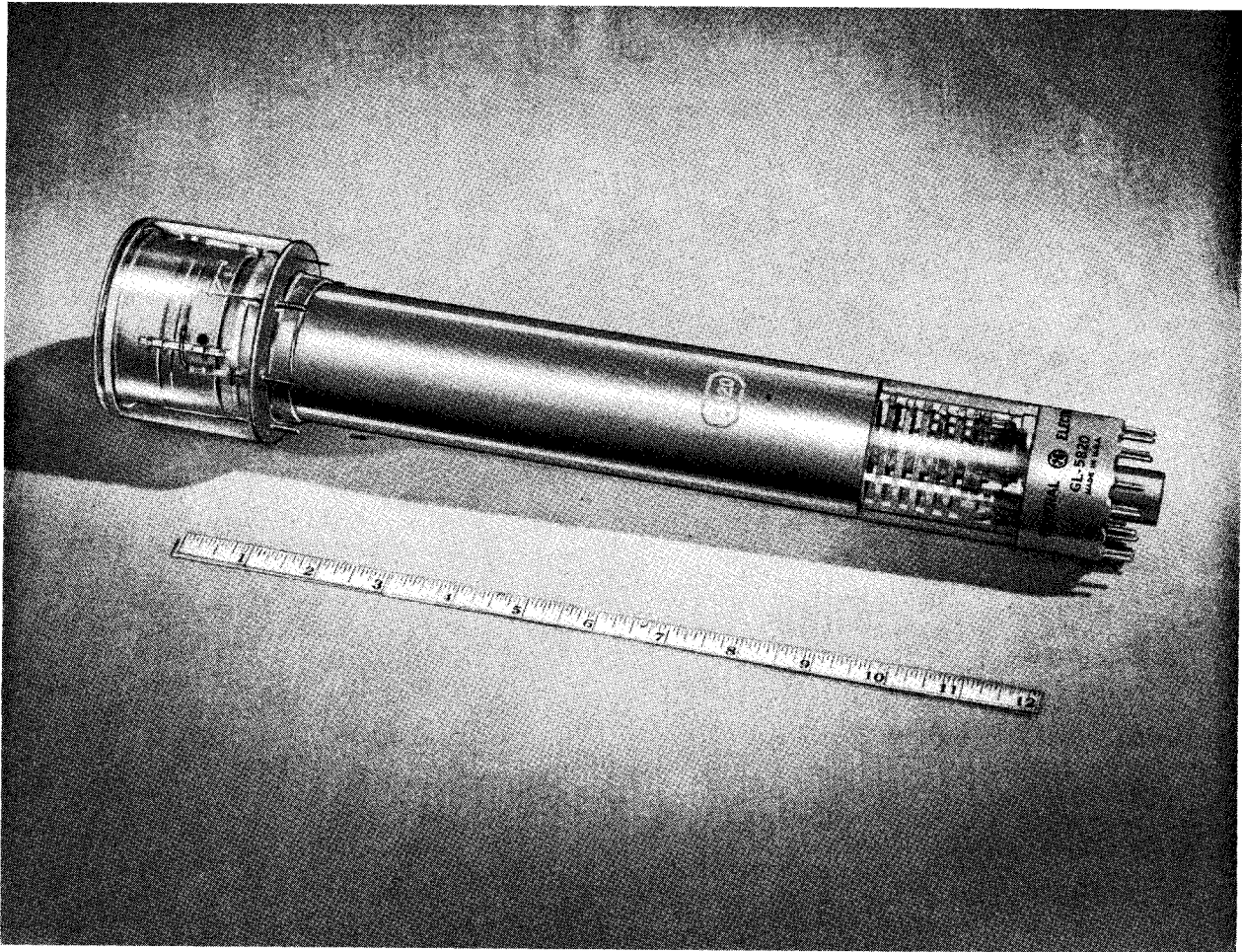

## IMAGE ORTHICON

The GL-5820 is a television camera tube for outdoor and studio pickup use in which exceptionally high sensitivity is combined with a spectral response approaching that of the eye. It is very stable in performance at all incident light levels on the object ranging from bright sunlight to a deep shadow (several thousand foot-candles to one foot-candle or less). Commercially acceptable pictures can be obtained at incident light

levels greater than about 10 foot-candles.

The GL-5820 has a photocathode characterized by a spectral response with high blue and high green sensitivity, very good yellow sensitivity, and good red sensitivity. It has practically no infrared sensitivity. This particular characteristic of the response permits portrayal of colors in nearly their true tonal gradation since it prevents any color-masking by infrared.

### TECHNICAL INFORMATION

#### GENERAL

##### Electrical

Cathode—Unipotential		
Heater Voltage, AC or DC.....	6.3 ± 10%	Volts
Heater Current.....	0.6	Amperes
Photocathode—Semi-transparent		
Response—See curve K-69087-72A333 on page 3 for details.		
Rectangular Image, 4 by 3 aspect ratio		
Useful Size, maximum diagonal.....	1.6	Inches
Focusing Method—Magnetic		
Deflecting Method—Magnetic		
Direct Interelectrode Capacitance		
Anode to All Other Electrodes.....	12	μf

GENERAL  ELECTRIC

Supersedes ETX-259 dated 6-50

## TECHNICAL INFORMATION (CONT'D)

## Mechanical

Over-all Length	$15\frac{3}{16} \pm \frac{1}{4}$	Inches
Greatest Diameter of Bulb	$3 \pm \frac{1}{16}$	Inches
Minimum Deflecting Coil Inside Diameter	$2\frac{3}{8}$	Inches
Deflecting Coil Length	5	Inches
Focusing Coil Length	10	Inches
Alignment Coil Length	$\frac{1}{8}$	Inches
Photocathode Distance Inside End of Focusing Coil	$\frac{1}{2}$	Inches
Weight, approximate	1.4	Pounds

## MAXIMUM RATINGS AND TYPICAL OPERATING CONDITIONS

## Maximum Ratings, Absolute Values

Photocathode Voltage	-550 Max	Volts
Photocathode Illumination	50 Max	Foot-Candles
Anode Supply Voltage*	1350 Max	Volts
Grid-No. 1 Voltage		
Negative Bias Value	125 Max	Volts
Positive Bias Value	0 Max	Volts
Grid-No. 2 and Dynode-No. 1 Voltage	350 Max	Volts
Grid-No. 3 Voltage	400 Max	Volts
Grid-No. 4 Voltage	300 Max	Volts
Grid-No. 5 Voltage	150 Max	Volts
Voltage Per Multiplier Stage	350 Max	Volts
Target Voltage		
Positive Value	10 Max	Volts
Negative Value	10 Max	Volts
Peak Heater-Cathode Voltage		
Heater Negative with Respect to Cathode	125 Max	Volts
Heater Positive with Respect to Cathode	10 Max	Volts
Operating Temperature of Any Part of Bulb	50 Max	C
Operating Temperature of Bulb at Large End of Tube (Target Section)	35 Min	C
Temperature Difference		
Between Target Section and Any Part of Bulb Hotter Than Target Section	5 Max	C

## Typical Operation

Photocathode Voltage (Image Focus)	-300 to -500	Volts
Grid-No. 1 Voltage for Picture Cut-off	-45 to -115	Volts
Grid-No. 2 and Dynode-No. 1 Voltage	300	Volts
Grid-No. 3 Voltage†	225 to 330	Volts
Grid-No. 4 Voltage (Beam Focus)	160 to 220	Volts
Grid-No. 5 Voltage (Decelerator)	0 to 125	Volts
Grid-No. 6 Voltage (Accelerator)		
75% of Photocathode Voltage	-225 to -375	Volts
Dynode-No. 2 Voltage	600	Volts
Dynode-No. 3 Voltage	800	Volts
Dynode-No. 4 Voltage	1000	Volts
Dynode-No. 5 Voltage	1200	Volts
Anode Voltage	1250	Volts
DC Anode Current	30	Microamperes
Target Voltage‡	0 to 3	Volts
Target Temperature Range	35 to 45	C
Ratio of Peak-to-Peak Highlight Video Signal		
Current to RMS Noise Current	35	
Minimum Peak-to-Peak Blanking Voltage	5	Volts
Field Strength at Center of Focusing Coil§	75	Gausses
Field Strength of Alignment Coil, approximate	0 to 3	Gausses

\* Ratio of dynode voltages is shown under Typical Operation.

† Adjust to give the most uniformly shaded picture near maximum signal.

‡ Adjustable from -3 to +5 volts with blanking voltage off.

§ Direction of current should be such that a north-seeking pole is attracted to the image end of the focusing coil, with the indicator located outside of and at the image end of the focusing coil.



TYPICAL SIGNAL OUTPUT  
SCENE: BLACK AND WHITE BALANCED  
TUNGSTEN, DAYLIGHT, OR WHITE FLUORESCENT LIGHT

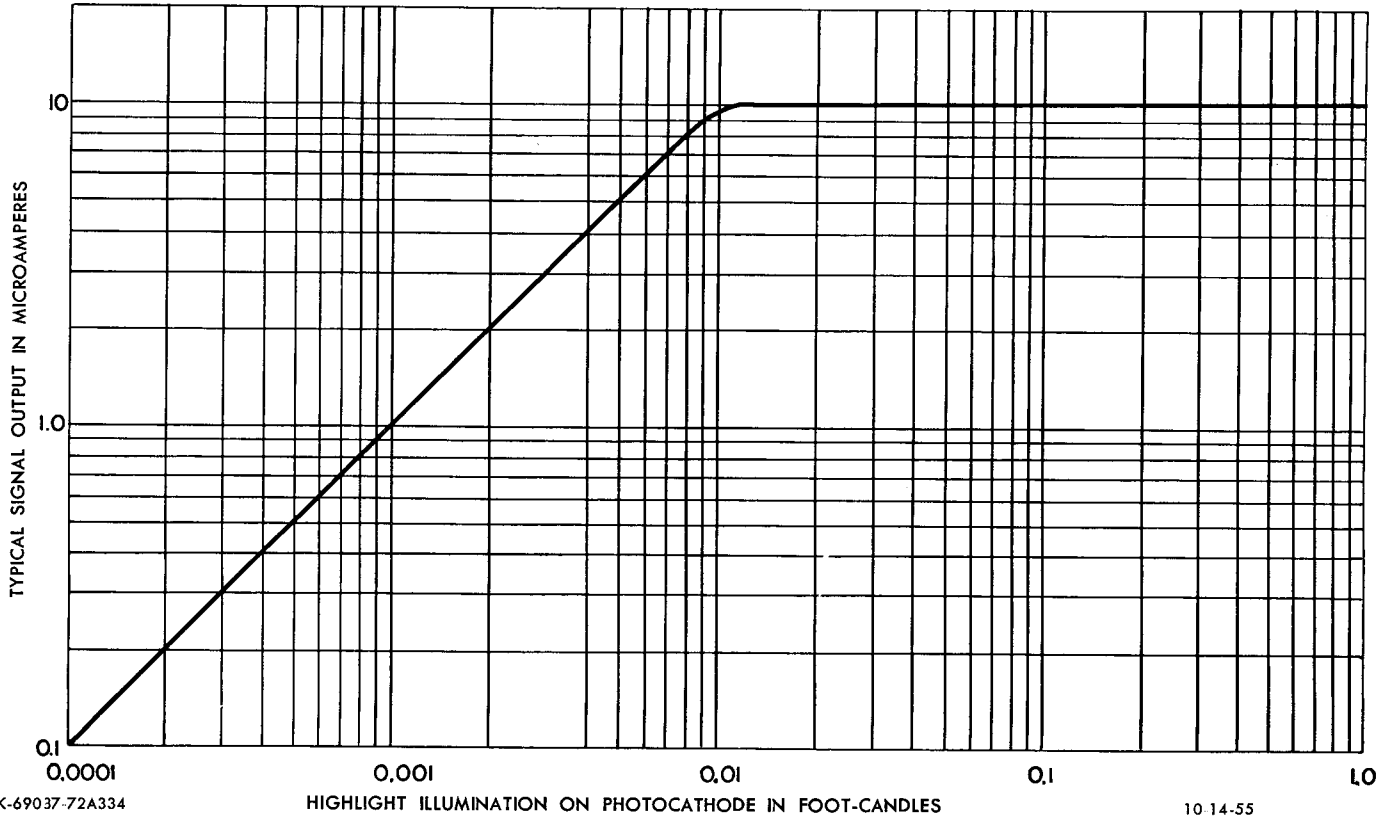

SPECTRAL SENSITIVITY CHARACTERISTIC  
FOR EQUAL VALUES OF RADIANT FLUX AT ALL WAVELENGTHS  
(DASHED CURVE SHOWS) SPECTRAL CHARACTERISTIC OF AVERAGE HUMAN EYE

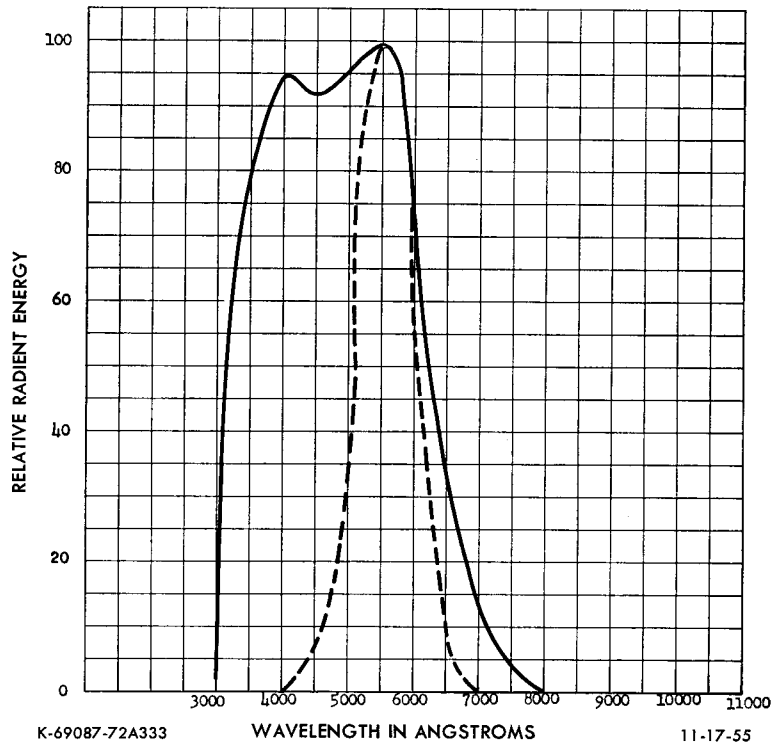

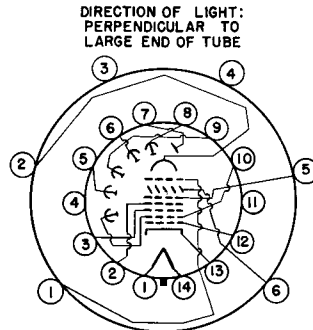
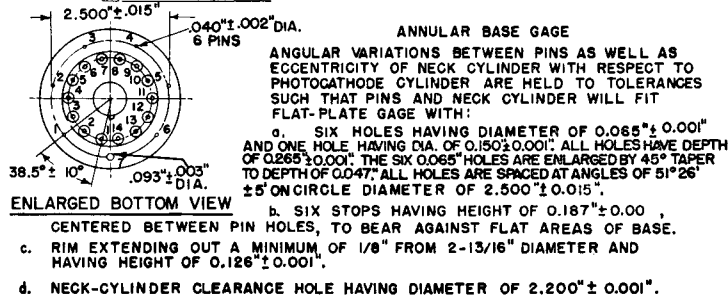
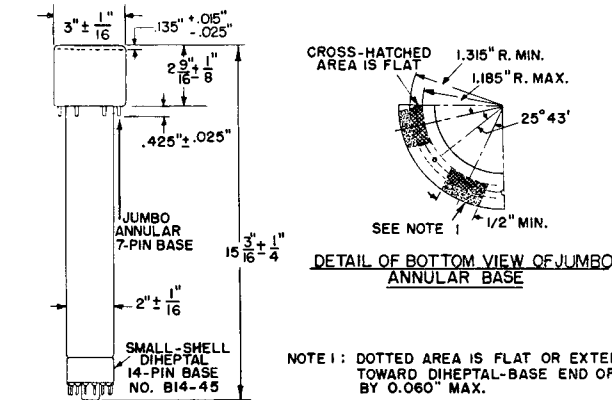

- SMALL-SHELL DIHEPTAL 14-PIN BASE**
- |                                       |                                  |  |
|---------------------------------------|----------------------------------|--|
| PIN 1: HEATER                         | PIN 6: DYNODE NO. 4              | PIN 11: INTERNAL CONNECTION-DO NOT USE |
| PIN 2: GRID NO. 4                     | PIN 7: ANODE                     | PIN 12: GRID NO. 1                     |
| PIN 3: GRID NO. 3                     | PIN 8: DYNODE NO. 5              | PIN 13: CATHODE                        |
| PIN 4: INTERNAL CONNECTION-DO NOT USE | PIN 9: DYNODE NO. 3              | PIN 14: HEATER                         |
| PIN 5: DYNODE NO. 2                   | PIN 10: DYNODE NO. 1, GRID NO. 2 |  |

**KEYED JUMBO ANNULAR 7-PIN BASE**

- |                                       |                                       |
|---------------------------------------|---------------------------------------|
| PIN 1: GRID NO. 6                     | PIN 5: GRID NO. 5                     |
| PIN 2: PHOTOCATHODE                   | PIN 6: TARGET                         |
| PIN 3: INTERNAL CONNECTION-DO NOT USE | PIN 7: INTERNAL CONNECTION-DO NOT USE |
| PIN 4: INTERNAL CONNECTION-DO NOT USE |                                       |

N-15118AZ

10-20-55

TEMPERATURE EFFECT ON AMPLITUDE RESPONSE

TELEVISION LINE NUMBER = 300

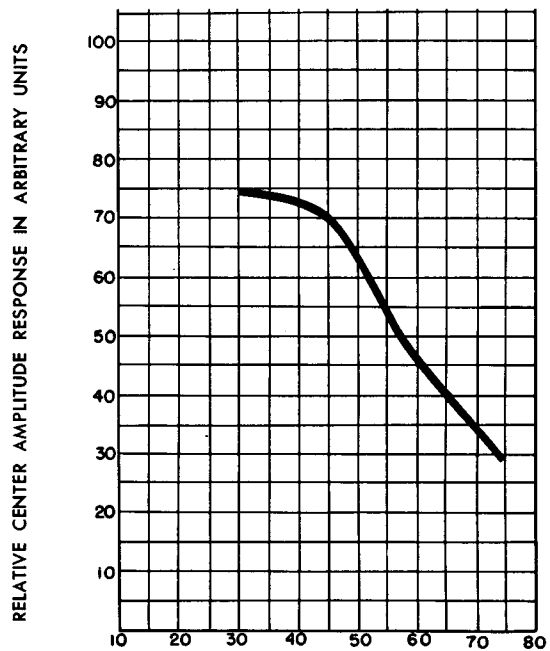

BULB TEMPERATURE ADJACENT TO TARGET IN C  
 AMPLITUDE RESPONSE CHARACTERISTICS

TEST PATTERN: SQUARE WAVE

OPERATING TEMPERATURE OF BULB ADJACENT TO TARGET = 35 C  
 RESPONSE MEASURED IN SYSTEM HAVING 10 MC BANDWIDTH

CURVE	HIGHLIGHTS IN RELATION TO LIGHT TRANSFER CHARACTERISTIC
A	AT KNEE
B	ONE LENS STOP ABOVE KNEE

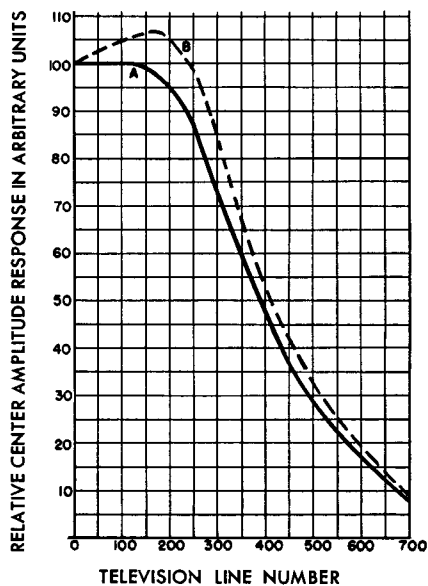

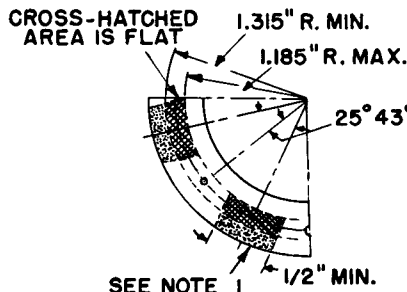
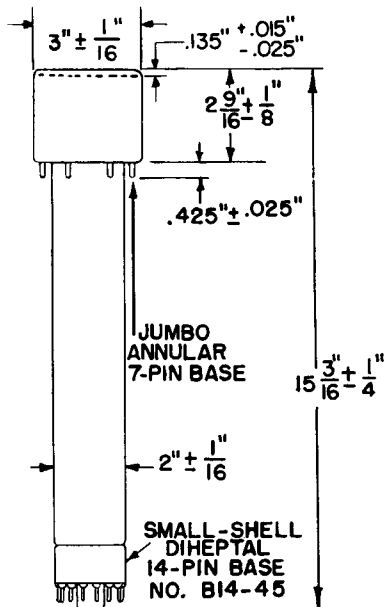

DETAIL OF BOTTOM VIEW OF JUMBO ANNULAR BASE

NOTE 1: DOTTED AREA IS FLAT OR EXTENDS TOWARD DIHEPTAL-BASE END OF TUBE BY 0.060" MAX.

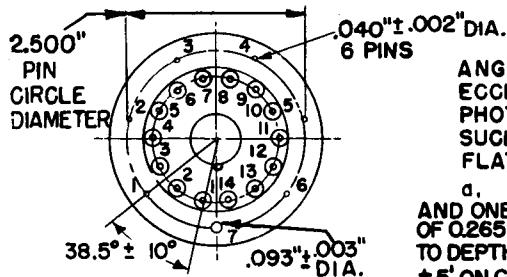

ENLARGED BOTTOM VIEW

ANNULAR BASE GAGE

ANGULAR VARIATIONS BETWEEN PINS AS WELL AS ECCENTRICITY OF NECK CYLINDER WITH RESPECT TO PHOTOCATHODE CYLINDER ARE HELD TO TOLERANCES SUCH THAT PINS AND NECK CYLINDER WILL FIT FLAT-PLATE GAGE WITH:

- a. SIX HOLES HAVING DIAMETER OF  $0.065 \pm 0.001$ " AND ONE HOLE HAVING DIA. OF  $0.150 \pm 0.001$ ". ALL HOLES HAVE DEPTH OF  $0.265 \pm 0.001$ ". THE SIX  $0.065$ " HOLES ARE ENLARGED BY  $45^\circ$  TAPER TO DEPTH OF  $0.047$ ". ALL HOLES ARE SPACED AT ANGLES OF  $51^\circ 26' \pm 5'$  ON CIRCLE DIAMETER OF  $2.500 \pm 0.001$ "
- b. SIX STOPS HAVING HEIGHT OF  $0.187 \pm 0.001$ ", CENTERED BETWEEN PIN HOLES, TO BEAR AGAINST FLAT AREAS OF BASE.
- c. RIM EXTENDING OUT A MINIMUM OF  $1/8$ " FROM  $2-13/16$ " DIAMETER AND HAVING HEIGHT OF  $0.126 \pm 0.001$ ".
- d. NECK-CYLINDER CLEARANCE HOLE HAVING DIAMETER OF  $2.200 \pm 0.001$ ".

DIRECTION OF LIGHT: PERPENDICULAR TO LARGE END OF TUBE

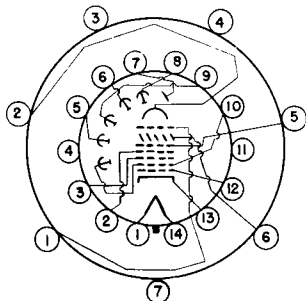

WHITE INDEX LINE ON FACE

SMALL-SHELL DIHEPTAL 14-PIN BASE

- |   |                                  |  |
|---|----------------------------------|--|
| PIN 1: HEATER                           | PIN 6: DYNODE NO. 4              | PIN 11: INTERNAL CONNECTION - DO NOT USE |
| PIN 2: GRID NO. 4                       | PIN 7: ANODE                     | PIN 12: GRID NO. 1                       |
| PIN 3: GRID NO. 3                       | PIN 8: DYNODE NO. 5              | PIN 13: CATHODE                          |
| PIN 4: INTERNAL CONNECTION - DO NOT USE | PIN 9: DYNODE NO. 3              | PIN 14: HEATER                           |
| PIN 5: DYNODE NO. 2                     | PIN 10: DYNODE NO. 1, GRID NO. 2 |  |

KEYED JUMBO ANNULAR 7-PIN BASE

- |   |   |
|---|---|
| PIN 1: GRID NO. 6                       | PIN 5: GRID NO. 5                       |
| PIN 2: PHOTOCATHODE                     | PIN 6: TARGET                           |
| PIN 3: INTERNAL CONNECTION - DO NOT USE | PIN 7: INTERNAL CONNECTION - DO NOT USE |
| PIN 4: INTERNAL CONNECTION - DO NOT USE |   |